

10G SFP+ Direct Attach Cable

(RoHS Compliant)

FEATURES

- Compliant with SFP+ MSA
- Compliant with SFP MSA (INF-8074i)
- Support for multi-gigabit data rates up to 10.5Gbps
- Support for 1x, 2x, 4x and 8x Fiber Channel data rates
- Hot Pluggable SFP 20PIN footprint
- Serial ID module on MOD(0-2)
- AC coupling of PECL signals
- EMI/EMC performance
- Low Power consumption<0.5W
- RoHS Compliant

OVERVIEW

OPTOWAY is devoted to providing reliable and outstanding direct attach cables (DAC) company. OPTOWAY 10~16Gbps SFP+ DAC is a high-speed solution with cost-effective design which can extend to 0.5~7m. 10Gbps DAC cable is compatible with 10G Ethernet(10GbE), Fiber Channel 1G,2G,4G,8G. 1x InfiniBand SDR, DDR, QDR, FDR applications.

ORDER INFORMATION

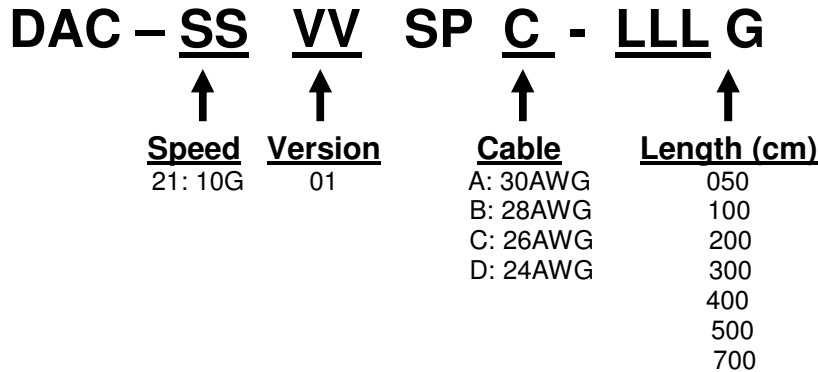

1. Absolute Maximum Ratings

Parameter	Symbol	Min.	Max.	Units
Storage Temperature	T_S	-40	85	°C
Supply Voltage	V_{CC3}	3.14	3.47	V

2. Recommended Operating Conditions

Parameter	Symbol	Min.	Max.	Units	Note
Storage Temperature		-40	85	°C	
Operating Case Temperature	T_C	0	70	°C	
Supply Voltage	V_{CC3}	3.14	3.47	V	
Power Dissipation	PD		0.5	W	

3. Electrical Characteristics

Parameter	Symbol	Min	Type	Max	Units	Notes
Supply Current	I_{CC}	-	-	100	mA	
Transmitter Differential Input Voltage (PECL)	V_{IN}	250	-	1200	mVpp	
Receiver Differential Output Voltage (PECL)	V_O	185	-	1000	mVpp	
Impedance	Z_{cable}	90	100	110	Ohms	
MOD-DEF1, 2	V_{IH}	2.0	-	V_{CC}	V	

Note: The supply current includes SFP Module's supply current and test board working current.

4. Important Notice

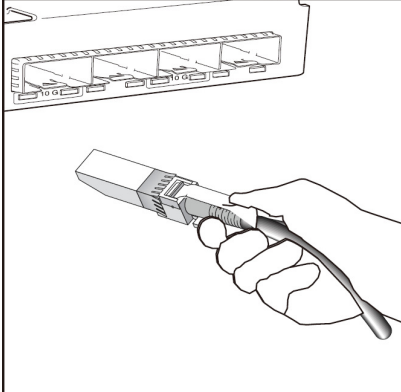
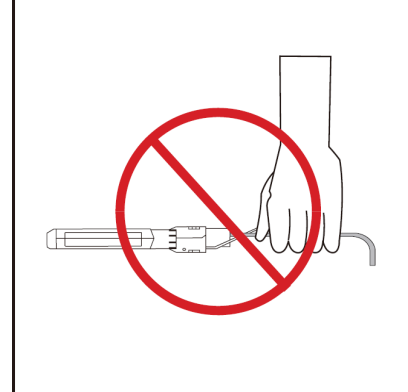
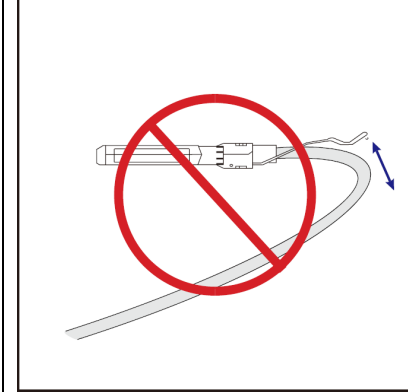
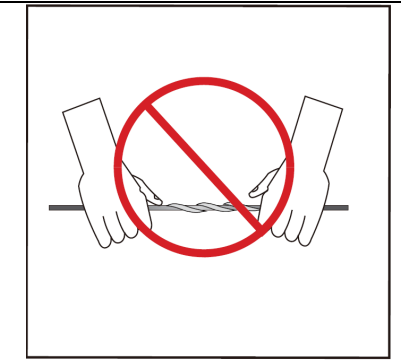
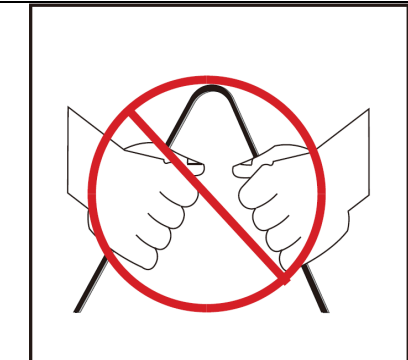
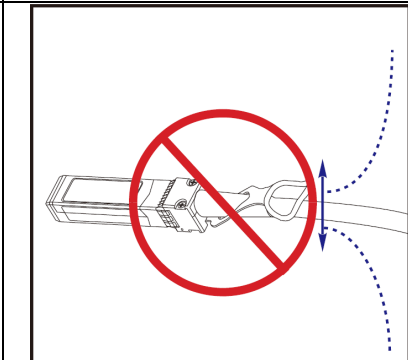
		
<p>Holding the SFP+ connector by its sides, insert the connector into the port on the switch</p>	<p>Do not handle by cable</p>	<p>DO NOT Over-bend the cable behind the connector</p>
		
<p>DO NOT twist the cable</p>	<p>DO NOT kink the cable</p>	<p>DO NOT bend up and down the cable</p>