SPB-3660WG / SPB-3660BWG / SPB-3660AWG (SC BIDI SFP) (RoHS Compliant)

SPB-3660LWG / SPB-3660BLWG / SPB-3660ALWG (LC BIDI SFP)

1310 nm TX / 1550 nm RX , 3.3V / 155 Mbps Digital Diagnostic Single-Fiber SFP Transceiver

FEATURES

- 1-Fiber Bi-Directional SFP Optical Transceiver
- Compliant with IEEE 802.3ah-2004 100BASE-BX
- Simplex **SC** Connector: **SPB-3660WG**
- Simplex **LC** Connector: **SPB-3660LWG**
- **SFF-8472 Digital Diagnostic Function**
- 1310 nm LD Transmitter
- 1550 nm Receiver
- Distance Up to 60 km
- AC/AC Coupling according to MSA
- Single +3.3 V Power Supply
- RoHS Compliant
- 0 to 70°C Operation: SPB-3660WG
- -10 to 85°C Operation: SPB-3660BWG
- -40 to 85°C Operation: SPB-3660AWG
- Class 1 Laser International Safety Standard IEC 60825 Compliant

APPLICATIONS

- WDM Fast Ethernet Links
- SONET/SDH Equipment Interconnect
- Fibre Channel Links

DESCRIPTION

The SPB-3660WG series are small form factor pluggable modules for IEEE 802.3ah 100BASE-BX and OC-3/STM-1 SONET/SDH single fiber communications by using 1310 nm transmitter and 1550 nm receiver. It is with the SFP 20-pin connector to allow hot plug capability. Digital diagnostic functions are available via an I²C. The transmitter section uses a multiple quantum well 1310 nm laser and is a class 1 laser compliant according to International Safety Standard IEC 60825. The receiver section uses an integrated 1550 nm detector preamplifier (IDP) mounted in an optical header and a limiting post-amplifier IC.

LASER SAFETY

This single mode transceiver is a Class 1 laser product. It complies with IEC 60825 and FDA 21 CFR 1040.10 and 1040.11. The transceiver must be operated within the specified temperature and voltage limits. The optical ports of the module shall be terminated with an optical connector or with a dust plug.

ORDER INFORMATION

| P/No. | Bit Rate (Mb/s) | Distance (km) | TX (nm) | RX (nm) | Package | Temp (°C) | TX Power (dBm) | RX Sens. (dBm) | RoHS Compliant |
|---------------------|-----------------|---------------|---------|---------|------------------------|-----------|----------------|----------------|----------------|
| SPB-3660WG | 125/155 | 60 | 1310 | 1550 | SC SFP with DMI | 0 to 70 | 0 to -5 | -34 | Yes |
| SPB-3660BWG | 125/155 | 60 | 1310 | 1550 | SC SFP with DMI | -10 to 85 | 0 to -5 | -34 | Yes |
| SPB-3660AWG | 125/155 | 60 | 1310 | 1550 | SC SFP with DMI | -40 to 85 | 0 to -5 | -34 | Yes |
| SPB-3660LWG | 125/155 | 60 | 1310 | 1550 | LC SFP with DMI | 0 to 70 | 0 to -5 | -34 | Yes |
| SPB-3660BLWG | 125/155 | 60 | 1310 | 1550 | LC SFP with DMI | -10 to 85 | 0 to -5 | -34 | Yes |
| SPB-3660ALWG | 125/155 | 60 | 1310 | 1550 | LC SFP with DMI | -40 to 85 | 0 to -5 | -34 | Yes |

| Absolute Maximum Ratings | | | | | |
|----------------------------|--------|-----|-----|-------|-------------|
| Parameter | Symbol | Min | Max | Units | Notes |
| Storage Temperature | Tstg | -40 | 85 | °C | |
| Operating Case Temperature | Topr | 0 | 70 | °C | SPB-3660WG |
| | | -10 | 85 | | SPB-3660BWG |
| | | -40 | 85 | | SPB-3660AWG |
| Power Supply Voltage | Vcc | 0 | 3.6 | V | |
| Input Voltage | --- | GND | Vcc | V | |
| Output Current | Iout | 0 | 30 | mA | |

| Recommended Operating Conditions | | | | | |
|----------------------------------|------------------------|-----|---------|-----|------------------|
| Parameter | Symbol | Min | Typ | Max | Units / Notes |
| Power Supply Voltage | Vcc | 3.1 | 3.3 | 3.5 | V |
| Power Supply Current | I _{CC(TX+RX)} | | 200 | 300 | mA |
| Operating Case Temperature | Topr | 0 | | 70 | °C / SPB-3660WG |
| | | -10 | | 85 | °C / SPB-3660BWG |
| | | -40 | | 85 | °C / SPB-3660AWG |
| Data Rate | | | 125/155 | 200 | Mb/s |

| Transmitter Specifications (0°C < Topr < 70°C, 3.1V < Vcc < 3.5V) | | | | | | |
|---|--|------|-----|---------|-------|-------------------|
| Parameter | Symbol | Min | Typ | Max | Units | Notes |
| Optical | | | | | | |
| Optical Transmit Power | P _o | -5 | | 0 | dBm | 1 |
| Output Center Wavelength | λ | 1270 | | 1360 | nm | |
| Output Spectrum Width | σ _λ | | | 3 | nm | RMS(σ) |
| Extinction Ratio | E _R | 10 | | | dB | |
| Output Eye | Compliant with Bellcore GR-253-CORE and ITU recommendation G.957 | | | | | |
| Optical Rise Time | t _r | | | 2 | ns | 10% to 90% Values |
| Optical Fall Time | t _f | | | 2 | ns | 10% to 90% Values |
| Relative Intensity Noise | RIN | | | -116 | dB/Hz | |
| Total Jitter | TJ | | | 1.0 | ns | 2 |
| Electrical | | | | | | |
| Data Input Current – Low | I _{IL} | -350 | | | μA | |
| Data Input Current – High | I _{IH} | | | 350 | μA | |
| Differential Input Voltage | V _{IH} - V _{IL} | 0.5 | | 2.4 | V | Peak-to-Peak |
| TX Disable Input Voltage – Low | T _{DIS,L} | 0 | | 0.5 | V | 3 |
| TX Disable Input Voltage – High | T _{DIS,H} | 2.0 | | Vcc | V | 3 |
| TX Disable Assert Time | T _{ASSERT} | | | 10 | μs | |
| TX Disable Deassert Time | T _{DEASSERT} | | | 1 | ms | |
| TX Fault Output Voltage -- Low | T _{FaultL} | 0 | | 0.5 | V | 4 |
| TX Fault Output Voltage -- High | T _{FaultH} | 2.0 | | Vcc+0.3 | V | 4 |

- Notes: 1. Output power is power coupled into a 9/125 μm single mode fiber.
 2. Measured with a 2²³-1 PRBS
 3. There is an internal 4.7K to 10K ohm pull-up resistor to VccTX.
 4. Open collector compatible, 4.7K to 10K ohm pull-up to Vcc (Host Supply Voltage).

| Receiver Specifications (0°C < Topr < 70°C, 3.1 V < Vcc < 3.5V) | | | | | | |
|---|-------------------|------|-----|--------------|---------|-------------------------|
| Parameter | Symbol | Min | Typ | Max | Units | Notes |
| Optical | | | | | | |
| Sensitivity | --- | --- | --- | -34 | dBm | 5 |
| Maximum Input Power | Pin | -8 | --- | --- | dBm | |
| Signal Detect – Asserted | Pa | --- | --- | -34 | dBm | Transition: low to high |
| Signal Detect – Deasserted | Pd | -43 | --- | --- | dBm | Transition: high to low |
| Signal detect – Hysteresis | | 1.0 | --- | | dB | |
| Wavelength of Operation | | 1480 | | 1580 | nm | 6 |
| Optical Return Loss | ORL | 14 | | | dB | |
| Electrical | | | | | | |
| Differential Output Voltage | $V_{OH} - V_{OL}$ | 0.6 | | 2.0 | V | |
| Output LOS Voltage -- Low | V_{OL} | 0 | | 0.5 | V | 7 |
| Output LOS Voltage – High | V_{OH} | 2.0 | | $V_{CC}+0.3$ | V | 7 |
| Signal Detect Assert Time | AS_{MAX} | | | 100 | μs | OFF to ON |
| Signal Detect Deassert Time | ANS_{MAX} | | | 300 | μs | ON to OFF |

Notes: 5. Minimum sensitivity and saturation levels at BER 1E-10 for a 2²³-1 PRBS.

6. At least 30 dB optical isolation for the wavelength 1260 to 1360 nm.

7. Open collector compatible, 4.7K to 10K ohm pull-up to Vcc (Host Supply Voltage).

RECOMMENDED CIRCUIT SCHEMATIC

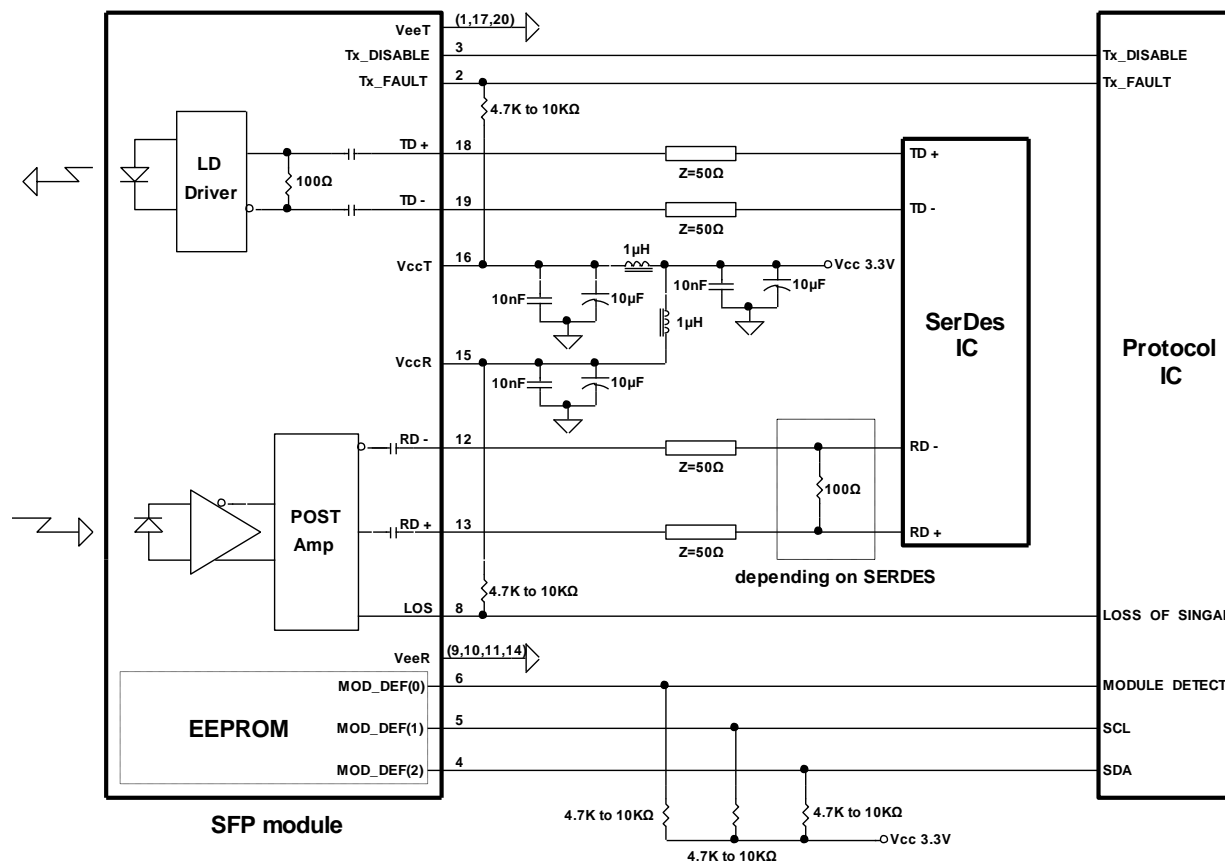

CONNECTION DIAGRAM

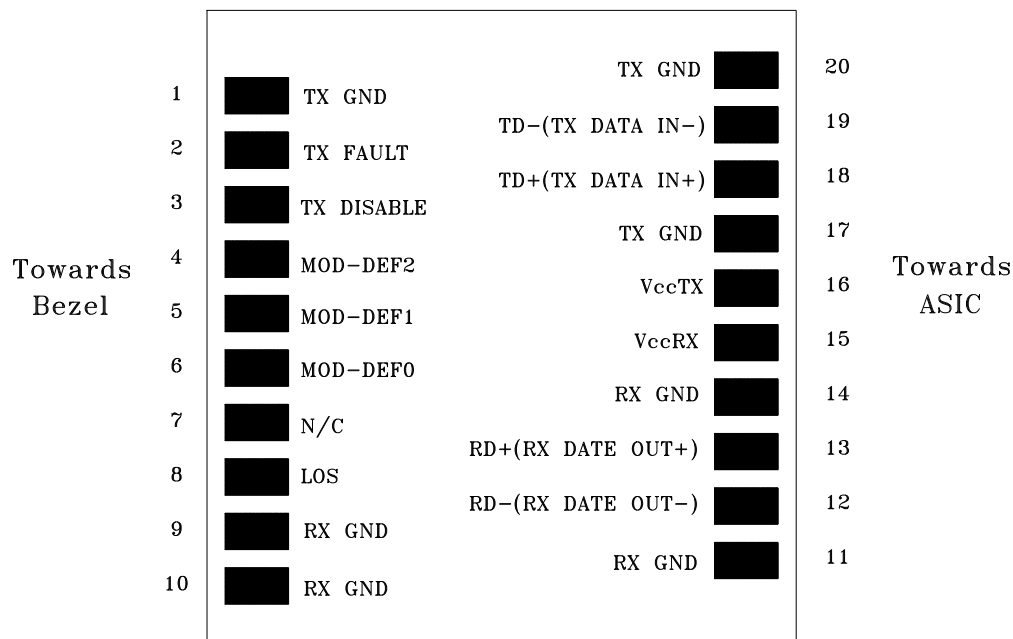

| PIN | Signal Name | Description | PIN | Signal Name | Description |
|-----|-------------|---|-----|--------------|-----------------------------|
| 1 | TX GND | Transmitter Ground | 11 | RX GND | Receiver Ground |
| 2 | TX Fault | Transmitter Fault Indication | 12 | RX DATA OUT- | Inverse Receiver Data Out |
| 3 | TX Disable | Transmitter Disable (Module disables on high or open) | 13 | RX DATA OUT+ | Receiver Data Out |
| 4 | MOD-DFE2 | Modulation Definition 2 – Two wires serial ID Interface | 14 | RX GND | Receiver Ground |
| 5 | MOD-DEF1 | Modulation Definition 1 – Two wires serial ID Interface | 15 | Vcc RX | Receiver Power – 3.3V±5% |
| 6 | MOD-DEF0 | Modulation Definition 0 – Ground in Module | 16 | Vcc TX | Transmitter Power – 3.3V±5% |
| 7 | N/C | Not Connected | 17 | TX GND | Transmitter Ground |
| 8 | LOS | Loss of Signal | 18 | TX DATA IN+ | Transmitter Data In |
| 9 | RX GND | Receiver Ground | 19 | TX DATA IN- | Inverse Transmitter Data In |
| 10 | RX GND | Receiver Ground | 20 | TX GND | Transmitter Ground |

Module Definition

| Module Definition | MOD-DEF2 PIN 4 | MOD-DEF1 PIN 5 | MOD-DEF0 PIN 6 | Interpretation by Host |
|-------------------|-------------------|-------------------|-------------------|-----------------------------------|
| 4 | SDA | SCL | LV-TTL Low | Serial module definition protocol |

Module Definition 4 specifies a serial definition protocol. For this definition, upon power up, MOD-DEF(1:2) appear as no connector (NC) and MOD-DEF(0) is TTL LOW. When the host system detects this condition, it activates the serial protocol. The protocol uses the 2-wire serial CMOS E²PROM protocol of the ATMEL AT24C01A/02/04 family of components.

PACKAGE DIAGRAM

Units in mm

A) SC SFP

Top View

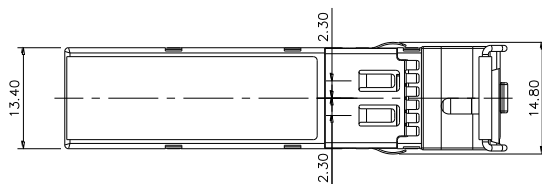

Front View

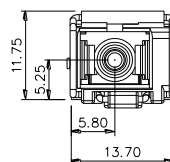
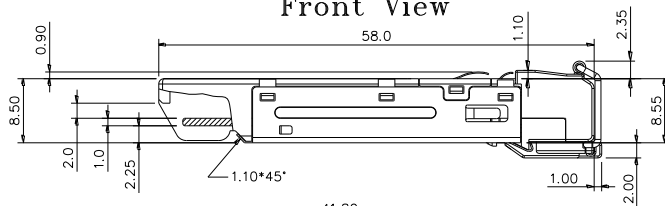

Side View

Bottom View

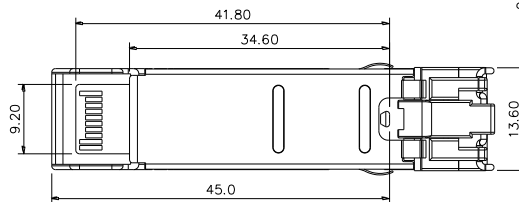

B) LC SFP

Top View

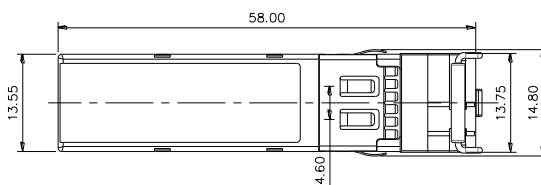

Front View

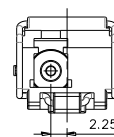
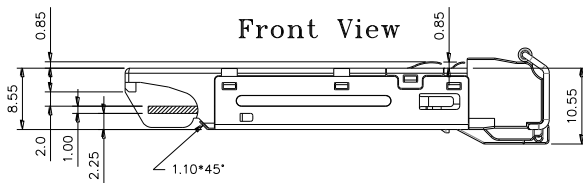

Side View

Bottom View

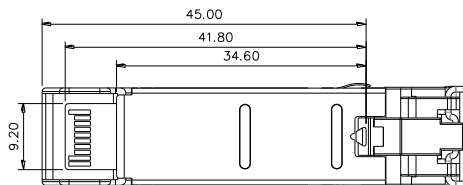

Note: Specifications subject to change without notice.

REVISION HISTORY

| Version | Subject | Release Date |
|---------|--|--------------|
| 1.0 | Initial datasheet | 2005/12/1 |
| 2.0 | Combine datasheet of SC BIDI SFP and LC BIDI SFP | 2006/3/1 |
| 3.0 | Revise SC BIDI SFP package diagram for high port density use | 2008/1/1 |
| 4.0 | Change package diagram | 2015/12/1 |
| | | |
| | | |