

SPB-9840G / SPB-9840BG / SPB-9840AG

(SC BIDI SFP) (RoHS Compliant)

SPB-9840LG / SPB-9840BLG / SPB-9840ALG

(LC BIDI SFP)

1310 nm TX / 1490 nm RX , 3.3V / 2.5 Gbps Single-Fiber SFP Transceiver

FEATURES

- 1-Fiber Bi-Directional SFP Optical Transceiver
- Simplex **SC** Connector: **SPB-9840G**
- Simplex **LC** Connector: **SPB-9840LG**
- Tri-rate for OC-48 / STM-16, Gigabit Ethernet 1000BASE & Fibre Channel
- 1310 nm DFB LD Transmitter
- 1490 nm Receiver
- Distance Up to 40 km
- AC/AC Coupling according to MSA
- Single +3.3 V Power Supply
- RoHS Compliant
- 0 to 70°C Operation: SPB-9840G
- -10 to 85°C Operation: SPB-9840BG
- -40 to 85°C Operation: SPB-9840AG
- Class 1 Laser International Safety Standard IEC 60825 Compliant

APPLICATIONS

- WDM OC-48 / STM-16 Links
- Gigabit Ethernet Interconnect
- Fibre Channel Links

DESCRIPTION

The SPB-9840G series are high performance module for OC-48 / STM-16 and Gigabit Ethernet 1000BASE single fiber communications by using 1310 nm transmitter and 1490 nm receiver. It is with the SFP 20-pin connector to allow hot plug capability. The transmitter section uses a multiple quantum well 1310 nm DFB laser and is a class 1 laser compliant according to International Safety Standard IEC 60825. The receiver section is designed to receive 1490 nm signal. The receiver section uses an integrated 1490 nm detector preamplifier (IDP) mounted in an optical header and a limiting post-amplifier IC.

LASER SAFETY

This single mode transceiver is a Class 1 laser product. It complies with IEC 60825 and FDA 21 CFR 1040.10 and 1040.11. The transceiver must be operated within the specified temperature and voltage limits. The optical ports of the module shall be terminated with an optical connector or with a dust plug.

ORDER INFORMATION

P/No.	Bit Rate (Gb/s)	Distance (km)	TX (nm)	RX (nm)	Package	Temp (°C)	TX Power (dBm)	RX Sens. (dBm)	RoHS Compliant
SPB-9840G	2.5	40	1310 DFB	1490	SC SFP	0 to 70	3 to -2	-20	Yes
SPB-9840BG	2.5	40	1310 DFB	1490	SC SFP	-10 to 85	3 to -2	-20	Yes
SPB-9840AG	2.5	40	1310 DFB	1490	SC SFP	-40 to 85	3 to -2	-20	Yes
SPB-9840LG	2.5	40	1310 DFB	1490	LC SFP	0 to 70	3 to -2	-20	Yes
SPB-9840BLG	2.5	40	1310 DFB	1490	LC SFP	-10 to 85	3 to -2	-20	Yes
SPB-9840ALG	2.5	40	1310 DFB	1490	LC SFP	-40 to 85	3 to -2	-20	Yes

Absolute Maximum Ratings

Parameter	Symbol	Min	Max	Units	Notes
Storage Temperature	Tstg	-40	85	°C	
Operating Case Temperature	Topr	0	70	°C	SPB-9840G SPB-9840BG SPB-9840AG
		-10	85		
		-40	85		
Relative Humidity	RH	0	85	%	No condensing
Power Supply Voltage	Vcc	0	3.6	V	
Input Voltage	---	GND	Vcc	V	
Output Current	Iout	0	30	mA	

Recommended Operating Conditions

Parameter	Symbol	Min	Typ	Max	Units / Notes
Power Supply Voltage	Vcc	3.13	3.3	3.47	V
Power Supply Current	I _{CC(TX+RX)}		200	300	mA
Operating Case Temperature	Topr	0		70	°C / SPB-9840G
		-10		85	°C / SPB-9840BG
		-40		85	°C / SPB-9840AG
Data Rate		622	2488	2670	Mb/s

Transmitter Specifications (0°C < Topr < 70°C, 3.13V < Vcc < 3.47V)

Parameter	Symbol	Min	Typ	Max	Units	Notes
Optical						
Optical Transmit Power	P _o	-2		3	dBm	1
Output Center Wavelength	λ	1261		1360	nm	
Output Spectrum Width	Δλ			1	nm	-20 dB width
Side Mode Suppression Ratio	SMSR	30			dB	
Extinction Ratio	E _R	8.2			dB	
Output Eye	Compliant with Telecordia GR-253-GORE and ITU-T Recommendation G.957					
Optical Rise Time	t _r			150	ps	20% to 80% Values
Optical Fall Time	t _f			150	ps	20% to 80% Values
Relative Intensity Noise	RIN			-120	dB/Hz	
Electrical						
Data Input Current – Low	I _{IL}	-350			μA	
Data Input Current – High	I _{IH}			350	μA	
Differential Input Voltage	V _{IH} - V _{IL}	0.5		2.4	V	Peak-to-Peak
TX Disable Input Voltage – Low	T _{DIS,L}	0		0.5	V	2
TX Disable Input Voltage – High	T _{DIS,H}	2.0		Vcc	V	2
TX Disable Assert Time	T _{ASSERT}			10	μs	
TX Disable Deassert Time	T _{DEASSERT}			1	ms	
TX Fault Output Voltage -- Low	T _{FaultL}	0		0.5	V	3
TX Fault Output Voltage -- High	T _{FaultH}	2.0		Vcc+0.3	V	3

- Notes: 1. Output power is power coupled into a 9/125 μm single mode fiber.
 2. There is an internal 4.7K to 10K ohm pull-up resistor to VccTX.
 3. Open collector compatible, 4.7K to 10K ohm pull-up to Vcc (Host Supply Voltage).

Receiver Specifications (0°C < T _{opr} < 70°C, 3.13 V < V _{cc} < 3.47V)						
Parameter	Symbol	Min	Typ	Max	Units	Notes
Optical						
Sensitivity	---	---	---	-20	dBm	4
Maximum Input Power	P _{in}	0	---	---	dBm	
Signal Detect -- Asserted	P _a	---	---	-20	dBm	Transition: low to high
Signal Detect -- Deasserted	P _d	-31	---	---	dBm	Transition: high to low
Signal detect -- Hysteresis		1.0	---		dB	
Wavelength of Operation		1480		1500	nm	5
Electrical						
Differential Output Voltage	V _{OH} - V _{OL}	0.6		2.0	V	
Output LOS Voltage -- Low	V _{OL}	0		0.5	V	6
Output LOS Voltage -- High	V _{OH}	2.0		V _{cc} +0.3	V	6
Signal Detect Assert Time	A _S MAX			100	μs	OFF to ON
Signal Detect Deassert Time	A _N SMAX			300	μs	ON to OFF

Notes: 4. Minimum sensitivity and saturation levels at BER 1E-10 for a 2²³-1 PRBS.
 5. At least 30 dB optical isolation for the wavelength 1260 to 1360 nm.
 6. Open collector compatible, 4.7K to 10K ohm pull-up to V_{cc} (Host Supply Voltage).

RECOMMENDED CIRCUIT SCHEMATIC

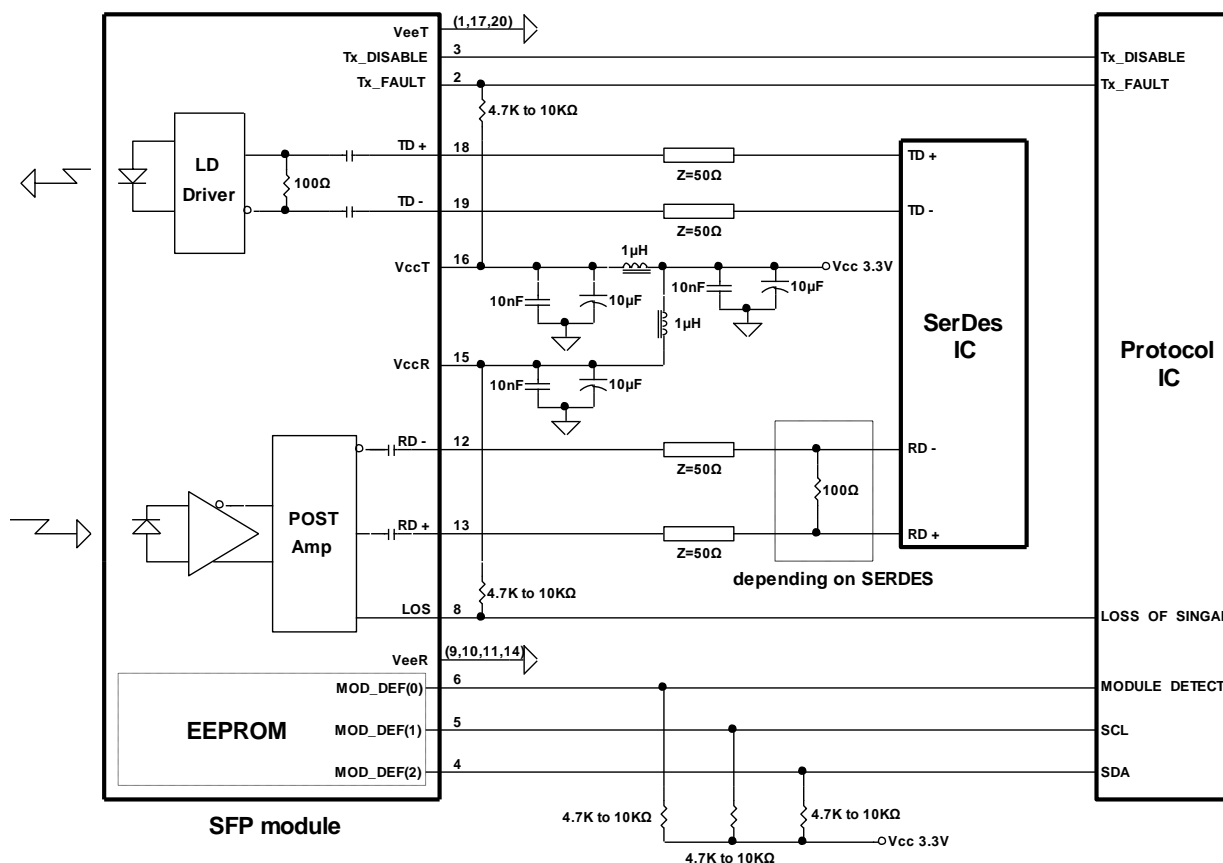

CONNECTION DIAGRAM



PIN	Signal Name	Description	PIN	Signal Name	Description
1	TX GND	Transmitter Ground	11	RX GND	Receiver Ground
2	TX Fault	Transmitter Fault Indication	12	RX DATA OUT-	Inverse Receiver Data Out
3	TX Disable	Transmitter Disable (Module disables on high or open)	13	RX DATA OUT+	Receiver Data Out
4	MOD-DFE2	Modulation Definition 2 – Two wires serial ID Interface	14	RX GND	Receiver Ground
5	MOD-DEF1	Modulation Definition 1 – Two wires serial ID Interface	15	Vcc RX	Receiver Power – 3.3V±5%
6	MOD-DEF0	Modulation Definition 0 – Ground in Module	16	Vcc TX	Transmitter Power – 3.3V±5%
7	N/C	Not Connected	17	TX GND	Transmitter Ground
8	LOS	Loss of Signal	18	TX DATA IN+	Transmitter Data In
9	RX GND	Receiver Ground	19	TX DATA IN-	Inverse Transmitter Data In
10	RX GND	Receiver Ground	20	TX GND	Transmitter Ground

Module Definition

Module Definition	MOD-DEF2 PIN 4	MOD-DEF1 PIN 5	MOD-DEF0 PIN 6	Interpretation by Host
4	SDA	SCL	LV-TTL Low	Serial module definition protocol

Module Definition 4 specifies a serial definition protocol. For this definition, upon power up, MOD-DEF(1:2) appear as no connector (NC) and MOD-DEF(0) is TTL LOW. When the host system detects this condition, it activates the serial protocol. The protocol uses the 2-wire serial CMOS E²PROM protocol of the ATMEL AT24C01A/02/04 family of components.

PACKAGE DIAGRAM

Units in mm

A) SC SFP

Top View

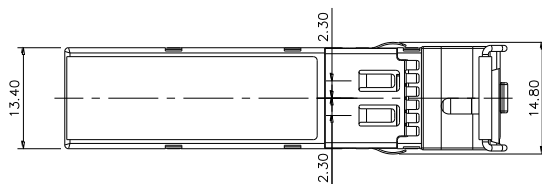

Front View

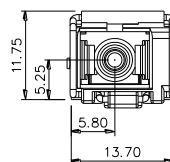
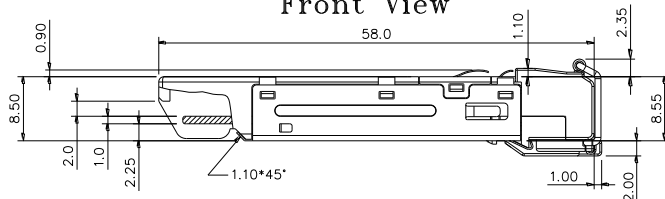

Side View

Bottom View

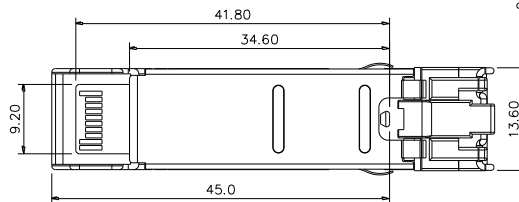

B) LC SFP

Top View

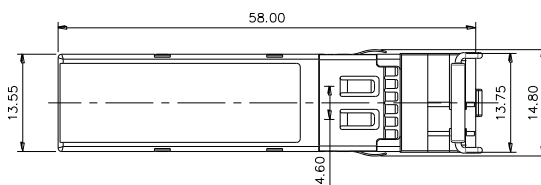

Front View

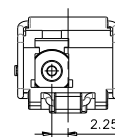
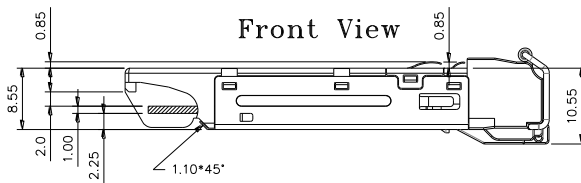

Side View

Bottom View

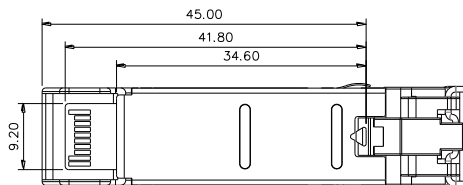

Note: Specifications subject to change without notice.

REVISION HISTORY

Version	Subject	Release Date
1.0	Initial datasheet	2005/12/1
2.0	Combine datasheet of SC BIDI SFP and LC BIDI SFP	2006/3/1
3.0	Revise SC BIDI SFP package diagram for high port density use	2008/1/1
4.0	Change package diagram	2015/12/1